

L I G H T I N G

C O M P O N E N T S A N D S Y S T E M S

2 0 1 1



B E R E T T A

Q U A L I T Y



L I G H T I N G

C O M P O N E N T S A N D S Y S T E M S

2 0 1 1

	5	Beretta S.r.l.
	7	Laboratorio di qualità Quality assurance laboratory Qualitätslabor
LIGHTING COMPONENTS	9	Morsetti Griplocks Drahtseilhalter
	16	Rosoni Ceiling attachments Deckenhalter
	18	Finali Screw caps Schraubkappen
	19	Raccordi Connectors Verbindungsstücke
	20	Cavi Cables Kabel
LIGHTING SYSTEMS	22	Esempi di sospensione Examples of suspension system Beispiele für Abhängungen

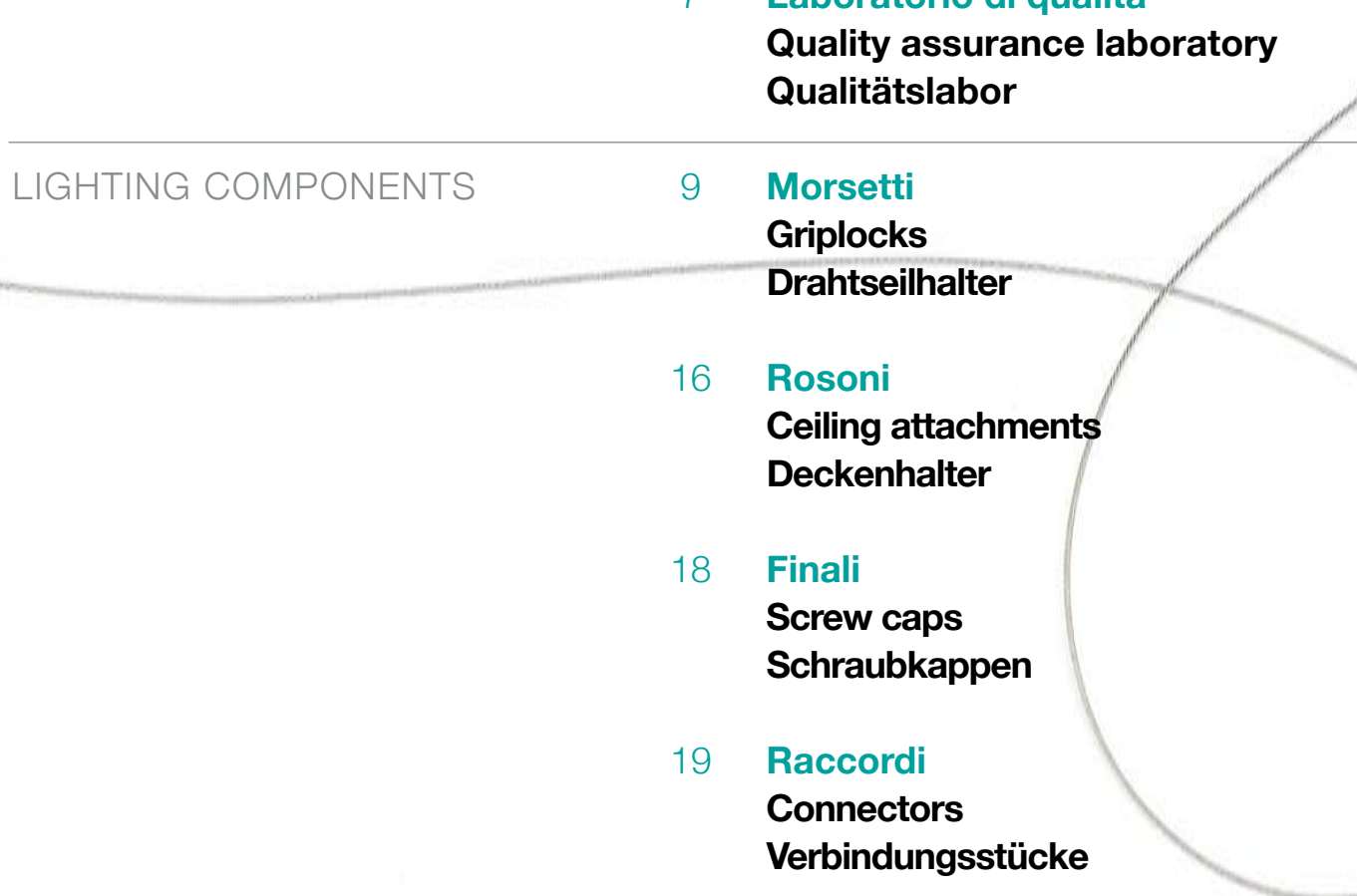

B E R E T T A

D E S I G N



B E R E T T A B O W D E N . C O M

Beretta S.r.l.

produce cavi e componenti per i sistemi di sospensione per l'illuminazione degli ambienti.

Ad un'ampia gamma di prodotti standard, Beretta affianca il design di componenti speciali realizzati in collaborazione con i propri clienti.

Lo sviluppo e l'innovazione dei prodotti sono accompagnati dalla cura nella realizzazione per assicurare elevata qualità e impatto estetico e garantire l'assoluta sicurezza della sospensione nel suo insieme.

Beretta S.r.l.

manufactures cables and components for suspension lighting systems.

Besides a wide range of standard products, Beretta offers special components designed in collaboration with its customers.

Product development and innovation are carried out with attention to details to ensure high quality and design and guarantee absolute safety in the suspension system as a whole.

Beretta S.r.l.

stellt Kabel und Komponenten für Aufhängungssysteme für die Raumbelichtung her.

Neben einer breiten Palette von Standardprodukten entwirft Firma Beretta Spezialkomponenten in Zusammenarbeit mit ihren Kunden.

Die ständige Weiterentwicklung und Erneuerung der Produkte bürgt zusammen mit der sorgfältigen Herstellung für hohe Qualität und ästhetisch ansprechende Produkte bei absolut sicherer Aufhängung.

Beretta S.r.l.

Via Manzoni 146

20811 Cesano Maderno MB, Italia

tel. +39.0362.528060

fax +39.0362.570096

infosales@BerettaBowden.com

www.BerettaBowden.com

B E R E T T A

E N G I N E E R I N G



ISO 9001:2000 and ISO TS 16949 certifications

Laboratorio di qualità

La qualità dei prodotti forniti, è garantita da differenti e costanti controlli, dalla materia prima in ingresso, proseguendo attraverso le varie fasi di lavorazione,



fino a test finali sul prodotto finito, eseguiti dal nostro laboratorio interno.

Certificazioni e schede di collaudo dei test effettuati, vengono da Beretta fornite ai clienti che ne fanno richiesta.

Quality assurance laboratory

The quality of Beretta's products is guaranteed by various and constant inspections, from the raw materials, continuing through the various stages of processing and continuing until the final tests of the finished products are performed in our laboratory.

Certification and test sheets of the tests we have performed are delivered by Beretta to our clients when requested.

Qualitätslabor

7

Die Qualität der gelieferten Produkte ist durch verschiedene, permanente Überwachungsprozesse beginnend beim Eintreffen der Rohmaterialien, fortfahrend über die unterschiedlichen Phasen der Produktion bis hin zum finalen Test der Endprodukte durch unser internes Prüflabor garantiert.

Prüfweise und Testprotokolle von Beretta können unseren Kunden auf Anfrage zur Verfügung gestellt werden.



B E R E T T A

M A N U F A C T U R I N G



B E R E T T A B O W D E N . C O M

Morsetti

Griplocks

Drahtseilhalter

LT 1009.0801

Morsetto automatico
M8 x 1
Nichelato

Griplock
M8 x 1
Nickel plated

Drahtseilhalter
M8 x 1
Vernickelt

 Ø 1,0 - 1,2 mm

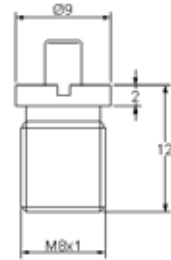

LT 1010.0802

Morsetto automatico
M8 x 1
Cromato

Griplock
M8 x 1
Chrome plated

Drahtseilhalter
M8 x 1
Verchromt

 Ø 1,0 - 1,2 mm

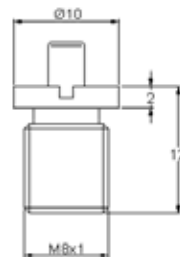

LT 1010.1002

Morsetto automatico
M10 x 1
Cromato

Griplock
M10 x 1
Chrome plated

Drahtseilhalter
M10 x 1
Verchromt

 Ø 1,0 - 1,6 mm

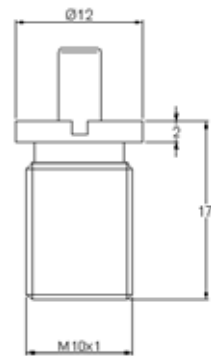

LT 1015.0802

Morsetto automatico
M8 x 1
Con ghiera di sicurezza
Cromato

Griplock
M8 x 1
With safety lock
Chrome plated

Drahtseilhalter
M8 x 1
Sicherung
Verchromt

 Ø 1,0 - 1,2 mm

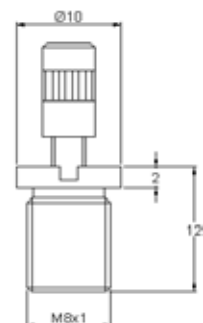

Morsetti

Griplocks

Drahtseilhalter

LT1015.1002

Morsetto automatico
M10 x 1
Con ghiera di sicurezza
Cromato

Griplock
M10 x 1
With safety lock
Chrome plated

Drahtseilhalter
M10 x 1
Sicherung
Verchromt



Ø 1,0 - 1,6 mm

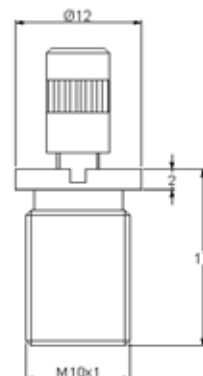

LT1040.1001

Morsetto automatico
M4
Con foro laterale
Nichelato

Griplock
M4
With side hole
Nickel plated

Drahtseilhalter
M4
Mit seitlicher Seilausführung
Vernickelt



Ø 1,0 - 1,6 mm

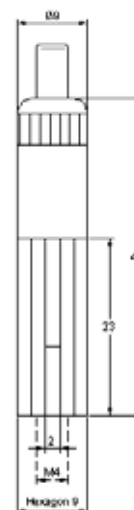

LT1050.0801

Morsetto automatico
M8
Nichelato

Griplock
M8
Nickel plated

Drahtseilhalter
M8
Vernickelt



Ø 1,0 - 1,6 mm

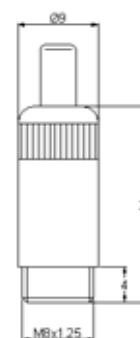

LT1051.0801

Morsetto automatico
M8 x 1
Nichelato

Griplock
M8 x 1
Nickel plated

Drahtseilhalter
M8 x 1
Vernickelt



Ø 1,0 - 1,6 mm

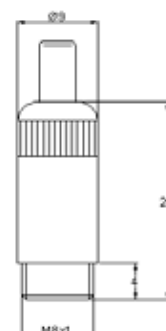

Morsetti

Griplocks

Drahtseilhalter

LT1020.1001

Morsetto automatico
M10 x 1
Nichelato

Griplock
M10 x 1
Nickel plated

Drahtseilhalter
M10 x 1
Vernickelt



Ø 1,0 - 1,6 mm

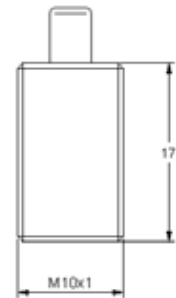

LT1065.0502

Morsetto automatico
M5
Con ghiera di sicurezza
Con foro laterale
Fresato
Cromato

Griplock
M5
With safety lock
With side hole
Milled
Chrome plated

Drahtseilhalter
M5
Sicherung
Mit seitlicher Seilaustrführung
Gerändelt
Verchromt



Ø 1,0 - 1,6 mm



LT1080.0402

Morsetto automatico
M4
Con foro laterale
Cromato

Griplock
M4
With side hole
Chrome plated

Drahtseilhalter
M4
Mit seitlicher Seilaustrführung
Verchromt



Ø 1,0 - 1,2 mm

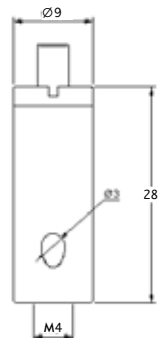

LT1081.0502

Morsetto automatico
M5
Con foro laterale
Cromato

Griplock
M5
With side hole
Chrome plated

Drahtseilhalter
M5
Mit seitlicher Seilaustrführung
Verchromt



Ø 1,0 - 1,6 mm

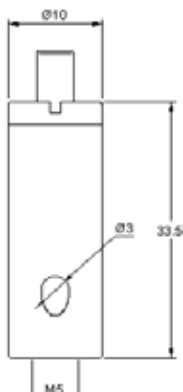

Morsetti

Griplocks

Drahtseilhalter

LT1082.0502

Morsetto automatico
M5
Con bilanciatore
integrato
Con foro laterale
Cromato

Griplock
M5
Integrated balancing
cylinder
With side hole
Chrome plated

Drahtseilhalter
M5
für Y-Seilaufhängungen

Mit seitlicher Seilaustrführung
Verchromt



Ø 1,0 - 1,6 mm

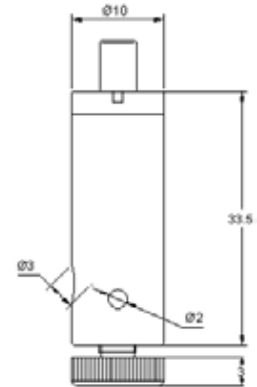

LT1083.0502

Morsetto automatico
M5
Con bilanciatore
integrato
Con foro laterale
Cromato

Griplock
M5
Integrated balancing
cylinder
With side hole
Chrome plated

Drahtseilhalter
M5
für Y-Seilaufhängungen

Mit seitlicher Seilaustrführung
Verchromt



Ø 1,0 - 1,6 mm

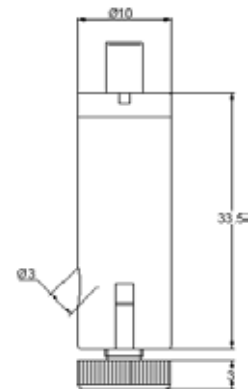

LT1084.0502

Morsetto automatico
M5
Con ghiera di sicurezza
Con bilanciatore
integrato
Con foro laterale
Cromato

Griplock
M5
With safety lock
Integrated balancing
cylinder
With side hole
Chrome plated

Drahtseilhalter
M5
Sicherung
für Y-Seilaufhängungen

Mit seitlicher Seilaustrführung
Verchromt



Ø 1,0 - 1,6 mm

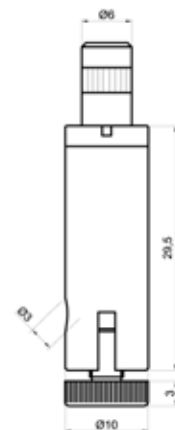

Morsetti

Griplocks

Drahtseilhalter

LT1085.0502

Morsetto automatico

M5

Con ghiera di sicurezza

Con foro laterale

Cromato

Griplock

M5

With safety lock

With side hole

Chrome plated

Drahtseilhalter

M5

Sicherung

Mit seitlicher Seilaustrführung

Verchromt



Ø 1,0 - 1,6 mm

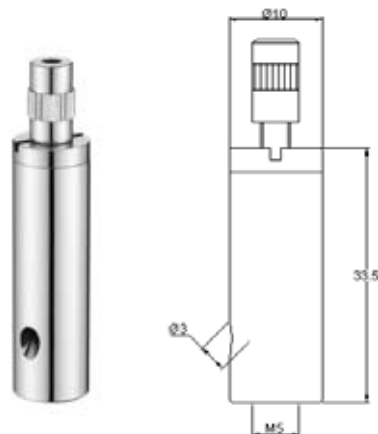

LT1090.0402

Morsetto automatico

M4

Cromato

Griplock

M4

Chrome plated

Drahtseilhalter

M4

Verchromt



Ø 1,0 - 1,2 mm

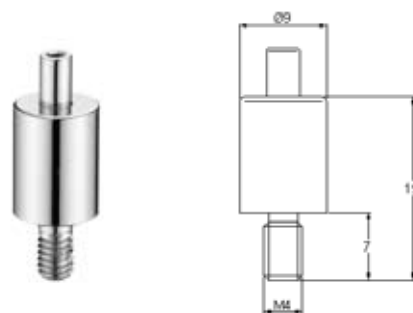

LT1090.0501

Morsetto automatico

M5

Nichelato

Griplock

M5

Nickel plated

Drahtseilhalter

M5

Vernickelt



Ø 1,0 - 1,2 mm

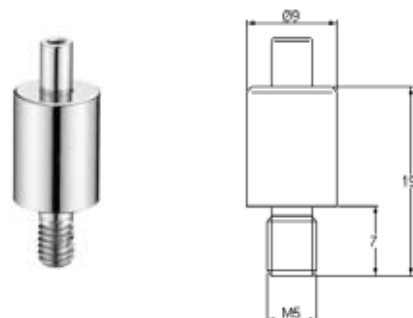

LT1100.0602

Morsetto automatico

M6

Con foro laterale

Cromato

Griplock

M6

With side hole

Chrome plated

Drahtseilhalter

M6

Mit seitlicher Seilaustrführung

Verchromt



Ø 1,0 - 1,6 mm

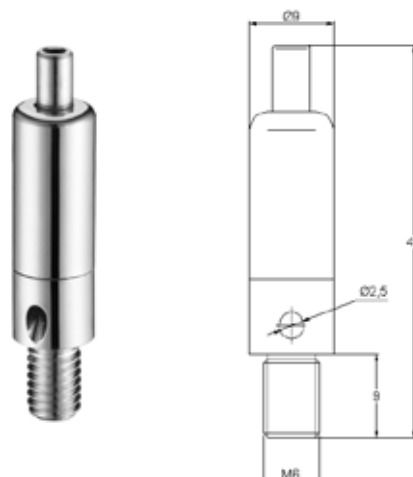

Morsetti

Griplocks

Drahtseilhalter

LT1115.1001

Morsetto automatico

M10 x 1

Con ghiera di sicurezza
Nichelato



Griplock

M10 x 1

With safety lock
Nickel plated

Ø 1,0 - 1,6 mm

Drahtseilhalter

M10 x 1

Sicherung
Vernickelt

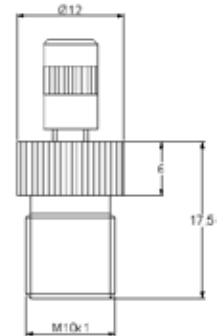

LT1115.1302

Morsetto automatico

M13 x 1

Con ghiera di sicurezza
Cromato



Griplock

M13 x 1

With safety lock
Chrome plated

Ø 1,9 - 2,5 mm

Drahtseilhalter

M13 x 1

Sicherung
Verchromt

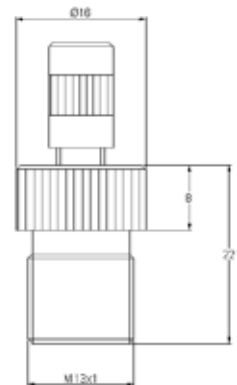

LT1120.1301

Morsetto automatico

M13 x 1

Nichelato



Griplock

M13 x 1

Nickel plated

Ø 1,0 - 1,6 mm

Drahtseilhalter

M13 x 1

Vernickelt

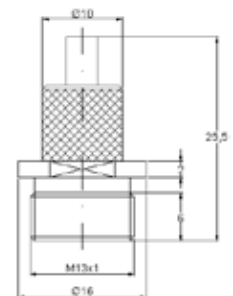

LT1062.0601

Morsetto automatico

M6 - M10 x 1

Con foro laterale
Nichelato



Griplock

M6 - M10 x 1

With side hole
Nickel plated

Ø 1,2 - 1,9 mm

Drahtseilhalter

M6 - M10 x 1

Mit seitlicher Seil-
ausführung
Vernickelt

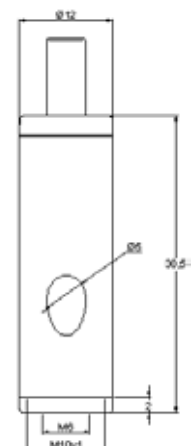

Morsetti

Griplocks

Drahtseilhalter

LT1061.0601

Morsetto automatico

Con ghiera di sicurezza
M6
Nichelato

Griplock

With safety lock
M6
Nickel plated

Drahtseilhalter

Sicherung
M6
Vernickelt

 Ø 1,0 - 1,6 mm

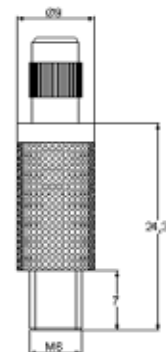

LT1060.0601

Morsetto automatico

Con ghiera di sicurezza
Con foro laterale
M6
Nichelato

Griplock

With safety lock
With side hole
M6
Nickel plated

Drahtseilhalter

Sicherung
Mit seitlicher Seilaustrführung
M6
Vernickelt

 Ø 1,0 - 1,6 mm

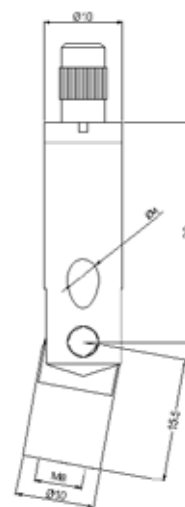

LT1064.0001

Morsetto automatico

M10 x 1
Con foro laterale
Con fondello
per attacco di tre cavi
Nichelato

Griplock

M10 x 1
With side hole
With base for three
cables
Nickel plated

Drahtseilhalter

M10 x 1
Mit seitlicher Seilaustrführung
Mit Basis für drei Seile
Vernickelt

 Ø 1,2 - 1,6 mm

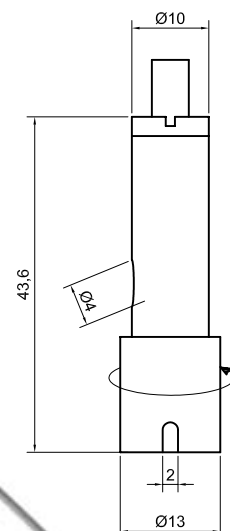

LT4040.0401

Morsetto a due viti

M4
Nichelato

Two screws lock

M4
Nickel plated

Seilhalter mit Schrauben

M4
Vernickelt

 Ø 1,0 - 1,9 mm

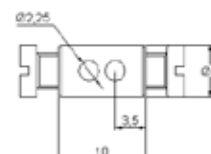

Rosoni

Ceiling attachments

Deckenhalter

LT2010.1002

Rosone con finale sferico
M10 x 1
Cromato

Ceiling attachment with spherical screw cap
M10 x 1
Chrome plated

Deckenhalter mit Schraubkappe kugelförmig
M10 x 1
Verchromt

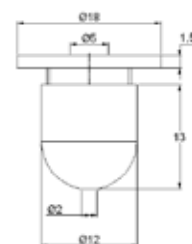

LT2020.0802

Rosone conico
M8 x 1
Cromato

Ceiling attachment conical
M8 x 1
Chrome plated

Deckenhalter konisch
M8 x 1
Verchromt



LT2020.1002

Rosone conico
M10 x 1
Cromato

Ceiling attachment conical
M10 x 1
Chrome plated

Deckenhalter konisch
M10 x 1
Verchromt



LT2030.0802

Rosone cilindrico
M8 x 1
Cromato

Ceiling attachment cylindrical
M8 x 1
Chrome plated

Deckenhalter zylindrisch
M8 x 1
Verchromt

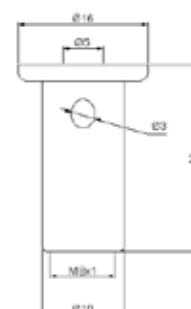

Rosoni

Ceiling attachments

Deckenhalter

LT2035.1002

Rosone cilindrico

M10 x 1
Cromato

Ceiling attachment
cylindrical
M10 x 1
Chrome plated

Deckenhalter zylindrisch

M10 x 1
Verchromt

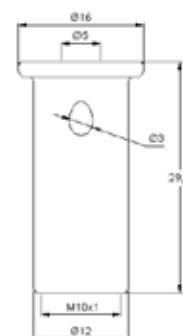

LT2040.1002

Rosone cilindrico
con taglio longitudinale
M10 x 1
Cromato

Ceiling attachment
cylindrical with slit
M10 x 1
Chrome plated

Deckenhalter zylindrisch
mit Schlitz
M10 x 1
Verchromt

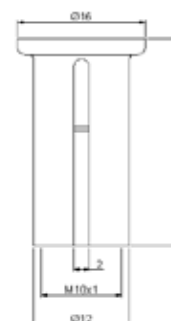

LT2050.1301

Rosone cilindrico

M13 x 1
Nichelato

Ceiling attachment
cylindrical
M13 x 1
Nickel plated

Deckenhalter zylindrisch

M13 x 1
Vernickelt

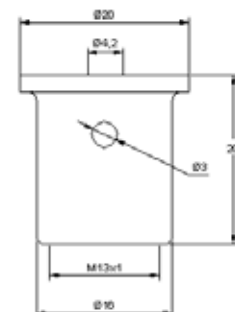

Finali

Screw caps

Schraubkappen

LT3010.0802

Finale fresato
M8 x 1
Cromato

Screw cap milled
M8 x 1
Chrome plated

Schraubkappe gerändelt
M8 x 1
Verchromt

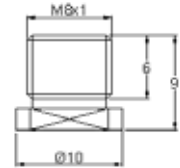

LT3010.1002

Finale fresato
M10 x 1
Cromato

Screw cap milled
M10 x 1
Chrome plated

Schraubkappe gerändelt
M10 x 1
Verchromt

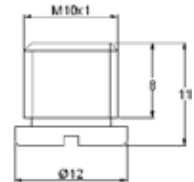

LT3020.0802

Finale zigrinato
M8 x 1
Cromato

Screw cap knurled
M8 x 1
Chrome plated

Schraubkappe längsgerändelt
M8 x 1
Verchromt

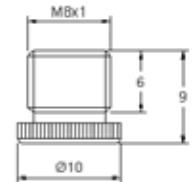

LT3020.1002

Finale zigrinato
M10 x 1
Cromato

Screw cap knurled
M10 x 1
Chrome plated

Schraubkappe längsgerändelt
M10 x 1
Verchromt

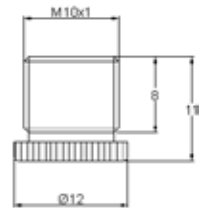

LT3040.0802

Finale fresato
M8 x 1
Cromato

Screw cap milled
M8 x 1
Chrome plated

Schraubkappe gerändelt
M8 x 1
Verchromt

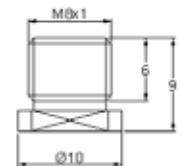

LT3040.1002

Finale fresato
M10 x 1
Cromato

Screw cap milled
M10 x 1
Chrome plated

Schraubkappe gerändelt
M10 x 1
Verchromt

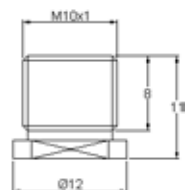

LT3040.1301

Finale fresato
M13 x 1
Nichelato

Screw cap milled
M13 x 1
Nickel plated

Schraubkappe gerändelt
M13 x 1
Vernickelt

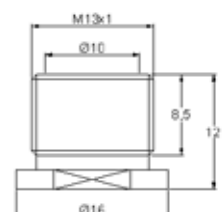

Raccordi

Connectors

Verbindungsstücke

LT4030.0802

Cilindro bilanciatore
M8 x 1
Cromato

Balancing cylinder
M8 x 1
Chrome plated

Zylinder
M8 x 1
Verchromt



LT4030.1002

Cilindro bilanciatore
M10 x 1
Cromato

Balancing cylinder
M10 x 1
Chrome plated

Zylinder
M10 x 1
Verchromt

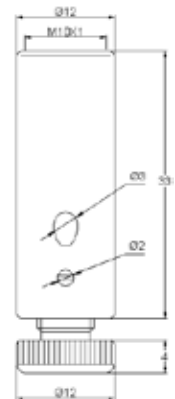

Cavi acciaio zincato
Galvanized steel cables
Verzinkter Stahl Kabel

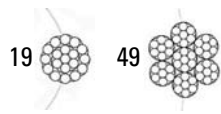

Terminale
Nipple
Nippel

Portata di sicurezza
Safety load
Zuglast

L3N	Ø 1 mm	19		Ø 3x3 mm	40 kg
L4N	Ø 1 mm	19		Ø 4x4 mm	50 kg
L3S	Ø 1 mm	49		Ø 3x3 mm	40 kg
L4S	Ø 1 mm	49		Ø 4x4 mm	50 kg
NGW	Ø 1,2 mm	19		Ø 3x3 mm	50 kg
GTW	Ø 1,2 mm	19		Ø 4x4 mm	80 kg
GTW mm SF55	Ø 1,2 mm	19		Ø 5,5 mm	80 kg
SGW	Ø 1,2 mm	49		Ø 3x3 mm	50 kg
S4W	Ø 1,2 mm	49		Ø 4x4 mm	80 kg
SGW mm SF55	Ø 1,2 mm	49		Ø 5,5 mm	80 kg
W mm 160G	Ø 1,5 mm	19		Ø 4x4 mm	150 kg
W mm 160N	Ø 1,5 mm	19		Ø 5,5 mm	150 kg
WS mm 160G	Ø 1,5 mm	49		Ø 4x4 mm	100 kg
WS mm 160N	Ø 1,5 mm	49		Ø 5,5 mm	100 kg



Cavi

Cables

Kabel

Cavi acciaio inox
Stainless steel
Edelstahl Kabel

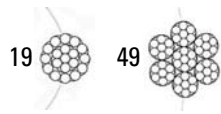

Terminale
Nipple
Nippel

Portata di sicurezza
Safety load
Zuglast

L3NX	Ø 1 mm	19		Ø 3x3 mm	30 kg
L4NX	Ø 1 mm	19		Ø 4x4 mm	40 kg
L3SX	Ø 1 mm	49		Ø 3x3 mm	30 kg
L4SX	Ø 1 mm	49		Ø 4x4 mm	40 kg
NGWX	Ø 1,2 mm	19		Ø 3x3 mm	50 kg
GTWX	Ø 1,2 mm	19		Ø 4x4 mm	60 kg
GTWX mm SF55	Ø 1,2 mm	19		Ø 5,5 mm	60 kg
SGWX	Ø 1,2 mm	49		Ø 3x3 mm	50 kg
S4WX	Ø 1,2 mm	49		Ø 4x4 mm	60 kg
SGWX mm SF55	Ø 1,2 mm	49		Ø 5,5 mm	60 kg
W4X mm 160G	Ø 1,5 mm	19		Ø 4x4 mm	120 kg
WX mm 160N	Ø 1,5 mm	19		Ø 5,5 mm	120 kg
WSX mm 160G	Ø 1,5 mm	49		Ø 4x4 mm	90 kg
WSX mm 160N	Ø 1,5 mm	49		Ø 5,5 mm	90 kg



**Esempio
di sospensione**

**Example of
suspension system**

**Beispiele für
Abhängungen**

Sistema di sospensione
con regolazione dell'altezza
vicino al corpo luminante.

Suspension system
with height adjustment
close to the light fixture.

Höhenverstellbare
Seilabhängesysteme am
Leuchtenkörper.



**Esempio
di sospensione**

**Example of
suspension system**

**Beispiele für
Abhängungen**

Sistema di sospensione
con regolazione dell'altezza
a soffitto.

Suspension system
with height adjustment
at the ceiling.

Höhenverstellbare
Seilabhängesysteme am
Deckenhalter.



L I G H T I N G

C O M P O N E N T S A N D S Y S T E M S

2 0 1 1

Beretta S.r.l.

Via Manzoni 146
20811 Cesano Maderno MB, Italia
tel. +39.0362.528060
fax +39.0362.570096
infosales@BerettaBowden.com
www.BerettaBowden.com

